



WanXiang Solar



SOLAR MODULES

WXS270P

Specifications

Cell Type	Multi-Silicon solar Cells
Cell Size	156mm×156mm
No. of cells and connections	72(6×12)
Dimension of module(mm)	1956×992×40mm
Weight	23.0Kg

Electrical Characteristics

Model	WXS270P
Maximum power at STC(Pm)	270W
Open-circuit voltage(Voc)	44.28V
Short-circuit current(Isc)	8.30A
Voltage at Pmax(Vmp)	36.36V
Current at Pmax(Imp)	7.43A
Application	DC 24V system

(STC:Irradiance AM1.5, 1000W/m², 25°C)

Limits

Fuse rating	15A
Maximum system voltage	1000VDC
Operating temperature	-40~+85°C

Temperature and Coefficients

NOCT	48°C ±2°C
Temp coefficient of Voc	-(140 ± 15)mV/°C
Temp coefficient of Isc	(0.08 ± 0.015)%/°C
Temp coefficient of power	-(0.4 ± 0.05)%/°C

NOCT:Nominal Operation Cell Temperature

Output

Type of output terminal	Junction box
Cable	4mm ²
Cable lengths	1000mm
Connector	Plug type

Mechanical Characteristics

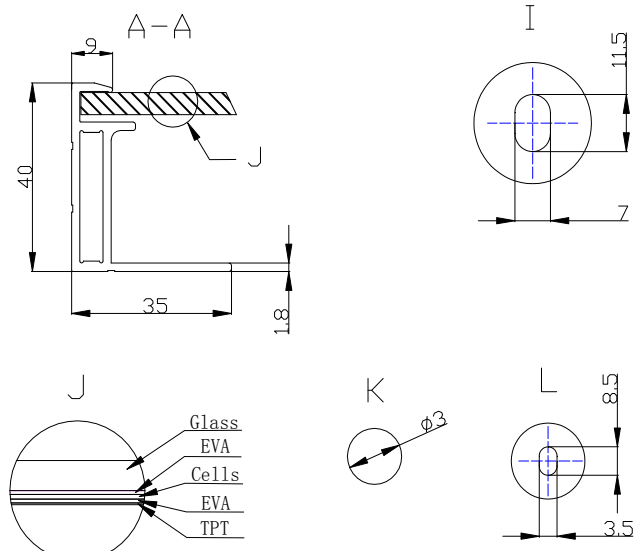
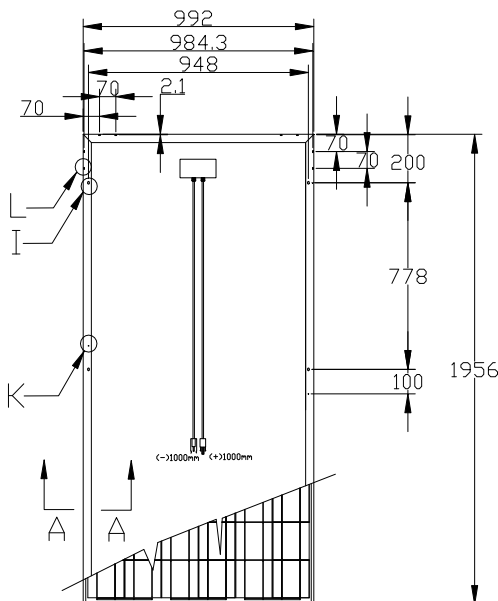

Characteristics Curve

