



# WanXiang Solar



## SOLAR MODULES WXS210P

### Specifications

Cell Type	Multi-Silicon solar Cells
Cell Size	156mm×156mm
No. of cells and connections	60(6×10)
Dimension of module(mm)	1640×992×40mm
Weight	19.0Kg

### Electrical Characteristics

Model	WXS210P
Maximum power at STC(Pm)	210W
Open-circuit voltage(Voc)	36.60V
Short-circuit current(Isc)	7.75A
Voltage at Pmax(Vmp)	30.00V
Current at Pmax(Imp)	7.00A

(STC:Irradiance AM1.5, 1000W/m<sup>2</sup>, 25°C)

### Limits

Fuse rating	15A
Maximum system voltage	1000VDC
Operating temperature	-40~+85°C

### Temperature and Coefficients

NOCT	48°C ±2°C
Temp coefficient of Voc	-(115 ±5)mV/°C
Temp coefficient of Isc	(0.08 ±0.015)%/°C
Temp coefficient of power	-(0.4 ±0.05)%/°C

NOCT:Nominal Operation Cell Temperature

### Output

Type of output terminal	Junction box
Cable	4mm <sup>2</sup>
Cable lengths	1000mm
Connector	Plug type

### Mechanical Characteristics

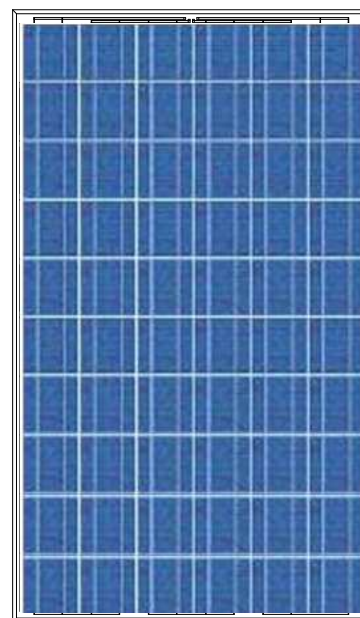
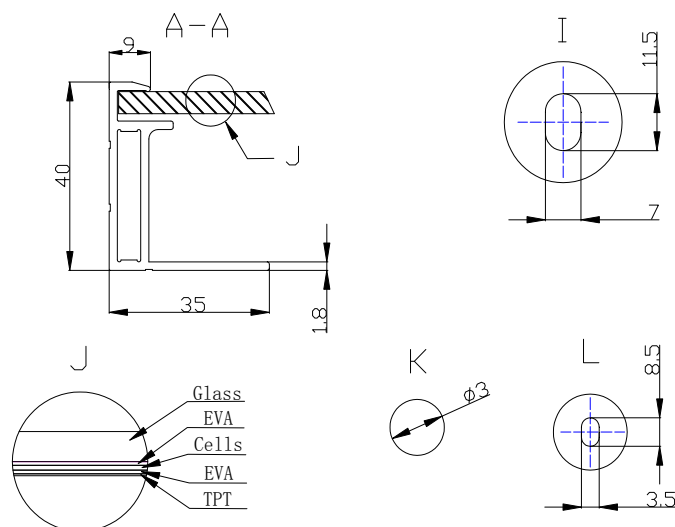
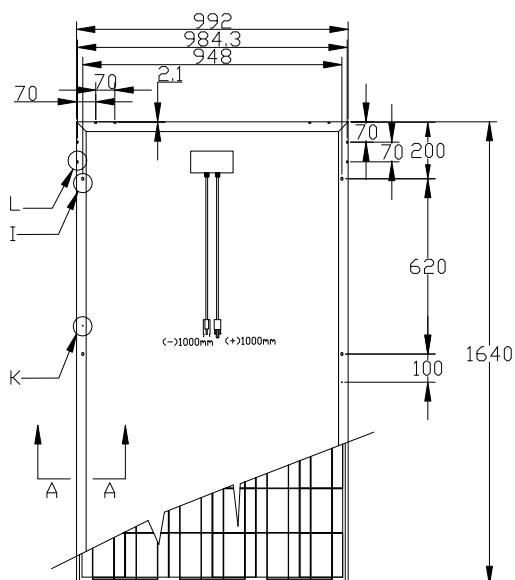

### Characteristics Curve

