



WanXiang Solar



SOLAR MODULES WXS120P

Specifications

Cell Type	Multi-Silicon solar Cells
Cell Size	156mm×156mm
No. of cells and connections	36(4×9)
Dimension of module(mm)	1480×669×30mm
Weight	12.0Kg

Electrical Characteristics

Model	WXS120P
Maximum power at STC(Pm)	120W
Open-circuit voltage(Voc)	21.96V
Short-circuit current(Isc)	7.52A
Voltage at Pmax(Vmp)	17.82V
Current at Pmax(Impp)	6.73A
Application	DC 12V system

(STC:Irradiance AM1.5, 1000W/m², 25°C)

Limits

Fuse rating	15A
Maximum system voltage	1000VDC
Operating temperature	-40~+85°C

Temperature and Coefficients

NOCT	48°C ±2°C
Temp coefficient of Voc	-(70 ±5)mV/°C
Temp coefficient of Isc	(0.08 ±0.015)%/°C
Temp coefficient of power	-(0.4 ±0.05)%/°C

NOCT:Nominal Operation Cell Temperature

Output

Type of output terminal	Junction box
Cable	4mm ²
Cable lengths	800mm
Connector	Plug type

Mechanical Characteristics

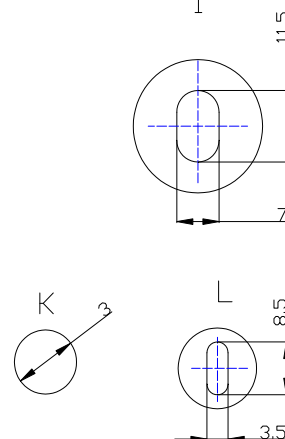
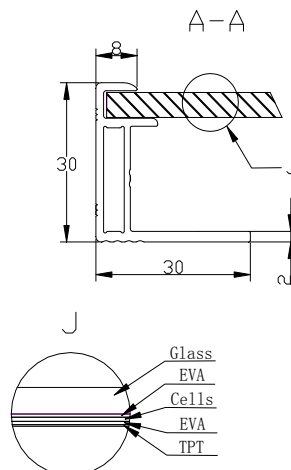
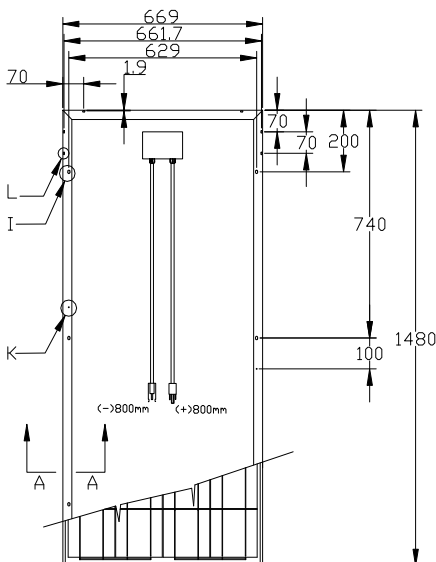

Characteristics Curve

