



WanXiang Solar



SOLAR MODULES WXS90S

Specifications

| | |
|------------------------------|--------------------------|
| Cell Type | Mono-Silicon solar Cells |
| Cell Size | 125mm×125mm |
| No. of cells and connections | 36(4×9) |
| Dimension of module(mm) | 1199×543×30mm |
| Weight | 7.0Kg |

Electrical Characteristics

| | |
|----------------------------|---------------|
| Model | WXS90S |
| Maximum power at STC(Pm) | 90W |
| Open-circuit voltage(Voc) | 22.14V |
| Short-circuit current(Isc) | 5.60A |
| Voltage at Pmax(Vmp) | 17.83V |
| Current at Pmax(Imp) | 5.05A |
| Application | DC 12V system |

(STC:Irradiance AM1.5, 1000W/m², 25°C)

Limits

| | |
|------------------------|-----------|
| Fuse rating | 10A |
| Maximum system voltage | 715VDC |
| Operating temperature | -40~+85°C |

Temperature and Coefficients

| | |
|---------------------------|-------------------|
| NOCT | 48°C±2°C |
| Temp coefficient of Voc | -(0.33±0.03)%/°C |
| Temp coefficient of Isc | (0.035±0.015)%/°C |
| Temp coefficient of power | -(0.5±0.05)%/°C |

NOCT:Nominal Operation Cell Temperature

Output

| | |
|-------------------------|------------------|
| Type of output terminal | Junction box |
| Cable | 4mm ² |
| Cable lengths | 800mm |
| Connector | Plug type |

Mechanical Characteristics

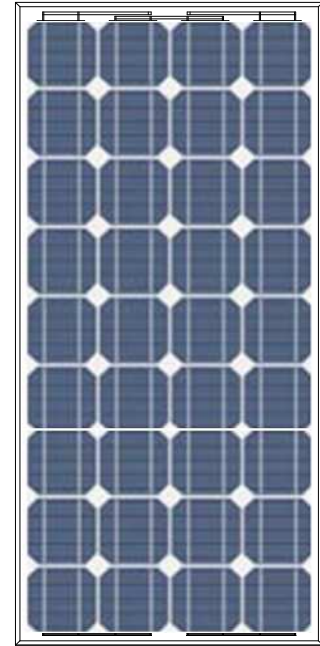
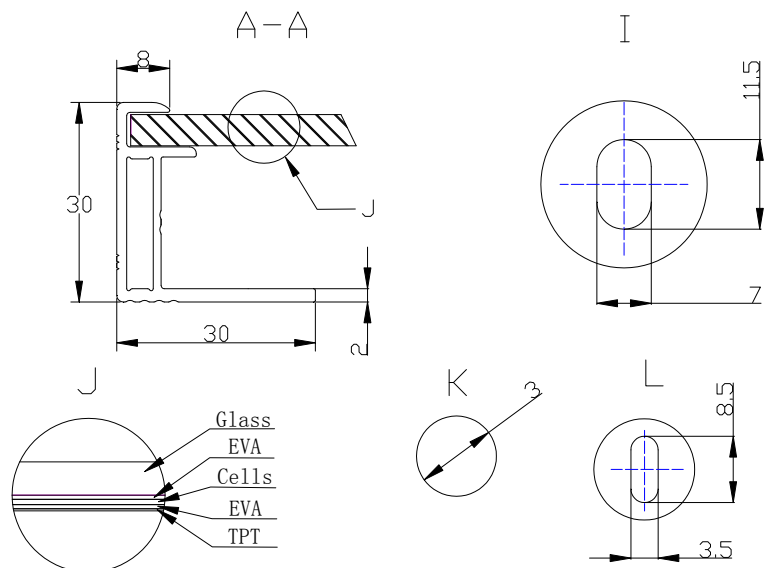
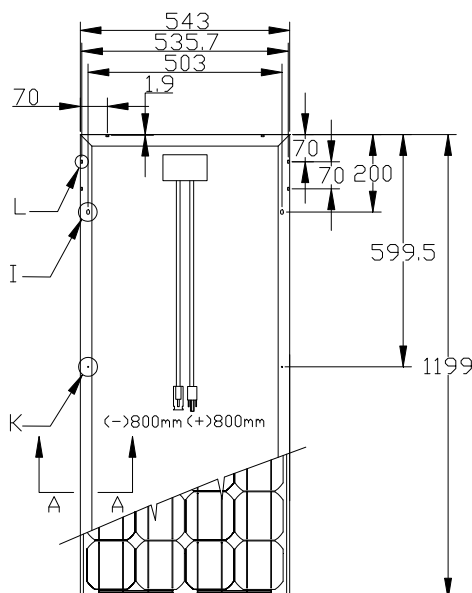

Characteristics Curve

