



WanXiang Solar



EUROTEST

Laboratori



SOLAR MODULES

WXS230S

Specifications

Cell Type	Mono-Silicon solar Cells
Cell Size	125mm×125mm
No. of cells and connections	91(7×13)
Dimension of module(mm)	1704×942×40mm
Weight	19.0Kg

Electrical Characteristics

Model	WXS230S
Maximum power at STC(Pm)	230W
Open-circuit voltage(Voc)	55.78V
Short-circuit current(Isc)	5.37A
Voltage at Pmax(Vmp)	46.50V
Current at Pmax(Imp)	4.95A

(STC:Irradiance AM1.5, 1000W/m², 25°C)

Limits

Fuse rating	15A
Maximum system voltage	1000VDC
Operating temperature	-40~+85°C

Temperature and Coefficients

NOCT	48°C±2°C
Temp coefficient of Voc	-(0.33±0.03)%/°C
Temp coefficient of Isc	(0.035±0.015)%/°C
Temp coefficient of power	-(0.5±0.05)%/°C

NOCT:Nominal Operation Cell Temperature

Output

Type of output terminal	Junction box
Cable	4mm ²
Cable lengths	1000mm
Connector	Plug type

Mechanical Characteristics

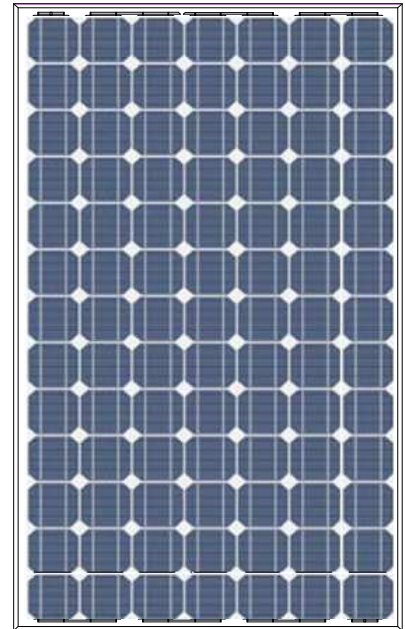
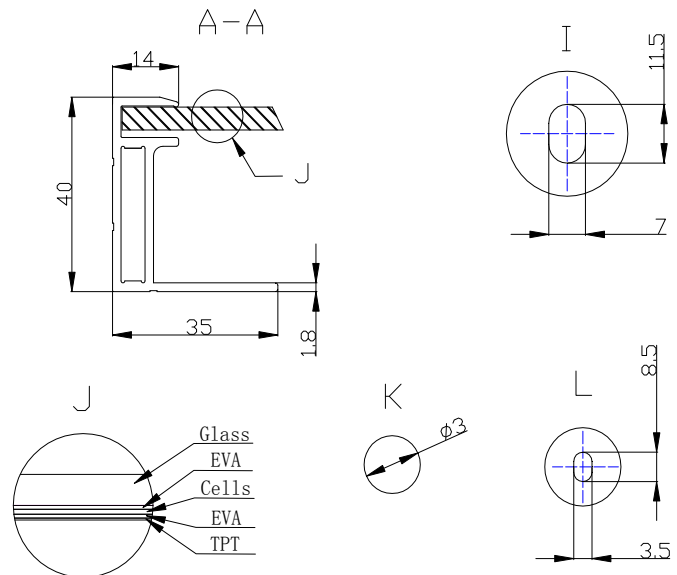
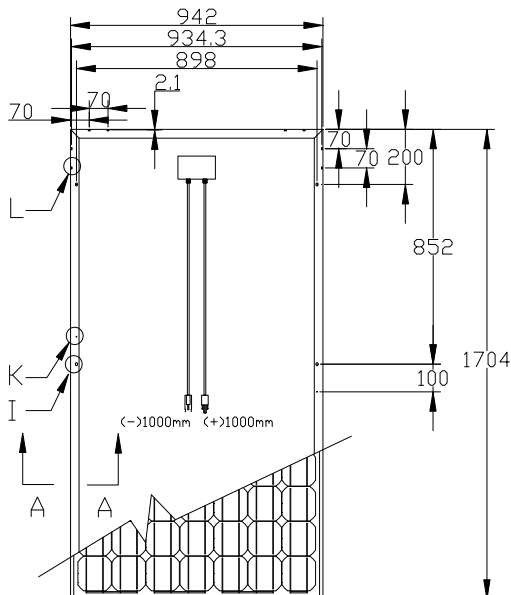

Characteristics Curve

